

# PRODUCT SPECIFICATION



**Part No. : JH-10Y14G40-R1C**  
**High Power LED**

## Catalog

1.Product Features	P2
2.Dimensions	P2
3.Absolute Maximum Rating	P3
4.Optical Character	P3
5.Optical Character Curves	P4
6.Spectrum Curves	P5
7.Viewing Angle Curves	P5
8.Cautions	P6

# 1.Product Features

- High Brightness Yellow LED
- Plane Package
- Viewing Angle 140 Degree
- Chip Material: AlGaInP
- RoHS Compliant

# 2.Dimensions

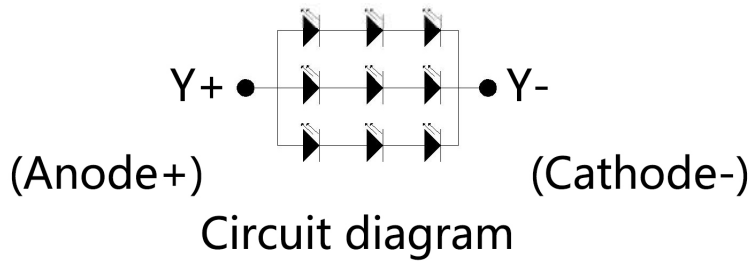
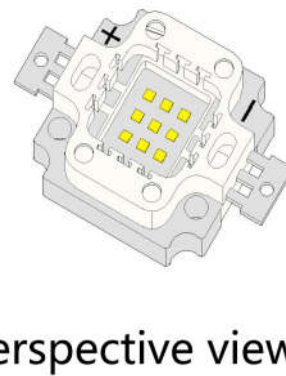
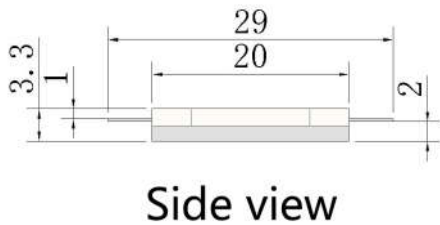
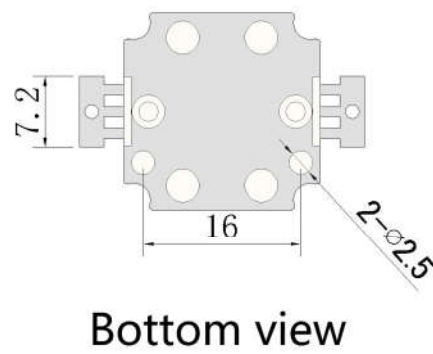
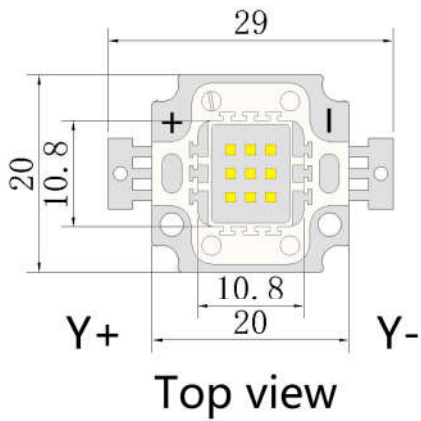

### Notes:

1. All dimensions are in millimeters.
2. Tolerance is  $\pm 0.1\text{mm}$  unless otherwise noted.

### 3. Absolute Maximum Rating @ Ta=25° C

Parameter	Symbol	Maximum Rating	Unit
Continuous Forward Current	IF	1050	mA
Peak Forward Current (1/10 Duty Cycle, 0.1ms Pulse Width)	IFp	1200	mA
Reverse Voltage	VR	9	V
Power Dissipation	PD	10	W
Electrostatic Discharge	ESD	1000	V
Operating Temperature Range	TOPR	-25°C to +80°C	
Storage Temperature Range	TSTG	-35°C to +100°C	
Lead Soldering Temperature	TSOL	260°C	

### 4. Optical Character @ Ta=25° C

Parameter	Symbol	Color	Min.	Typ.	Max.	Unit	Test Condition
Forward Voltage	VF	Y	6	6.5	7	V	I <sub>F</sub> =1050mA
Luminous Flux	Φ	Y	300	400	500	Lm	I <sub>F</sub> =1050mA
Dominant Wavelength	Wld	Y	590	592.5	595	nm	I <sub>F</sub> =1050mA
Reverse Current	IR		0		10	μA	V <sub>R</sub> =9V
Viewing Angle	2θ1/2				140	deg	I <sub>F</sub> =1050mA
Recommend Forward Current	IF(rec)	Y			1050	mA	

#### Notes:

Measurement tolerance of forward voltage ±0.1V

## 5. Optical Character Curves

( 25 ° Ambient Temperature Unless Otherwise Noted )

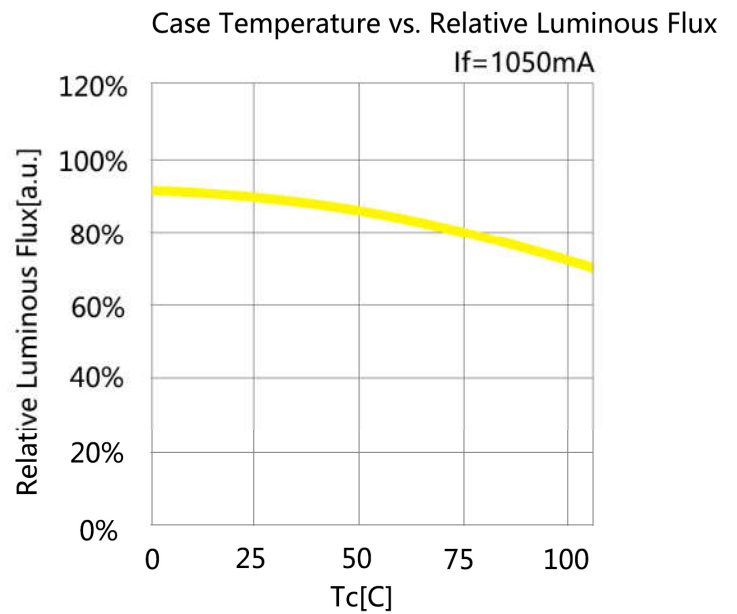
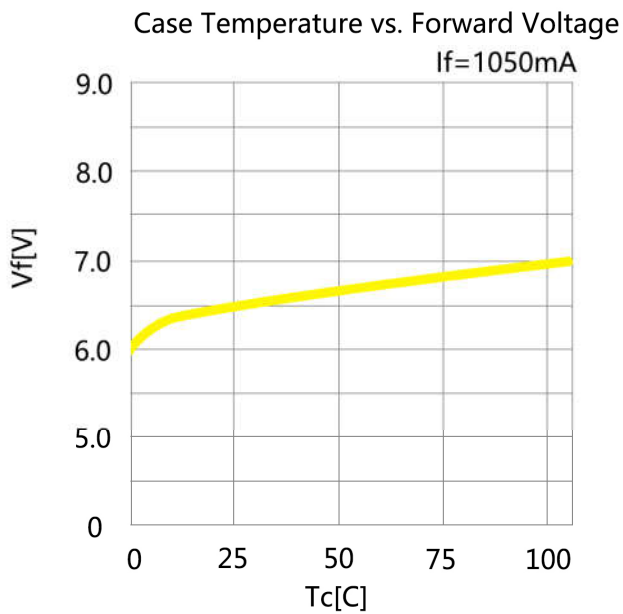
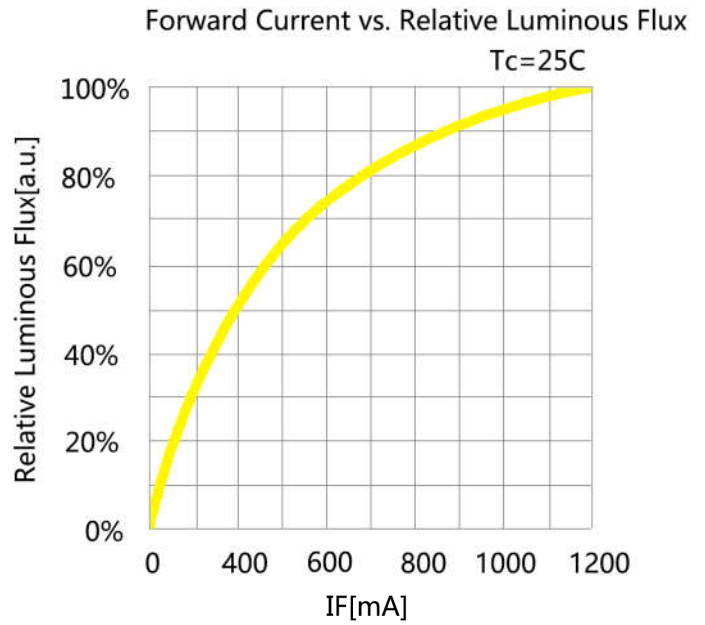
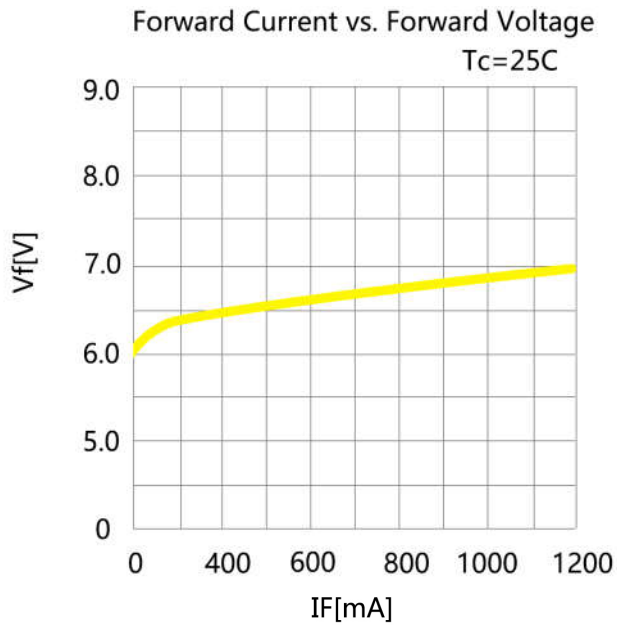

## 6. Spectrum Curves

IF=1050mA

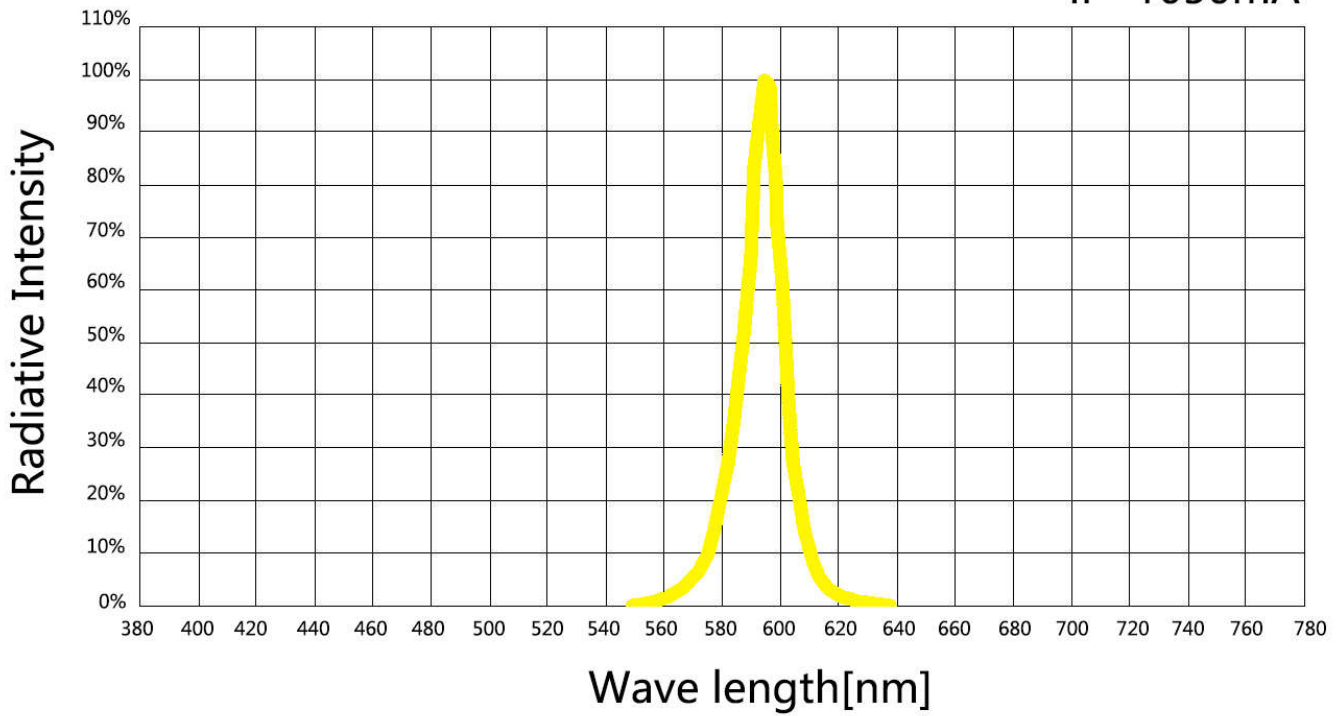

## 7. Viewing Angle Curves

Radiation Characteristic

IF=1050mA

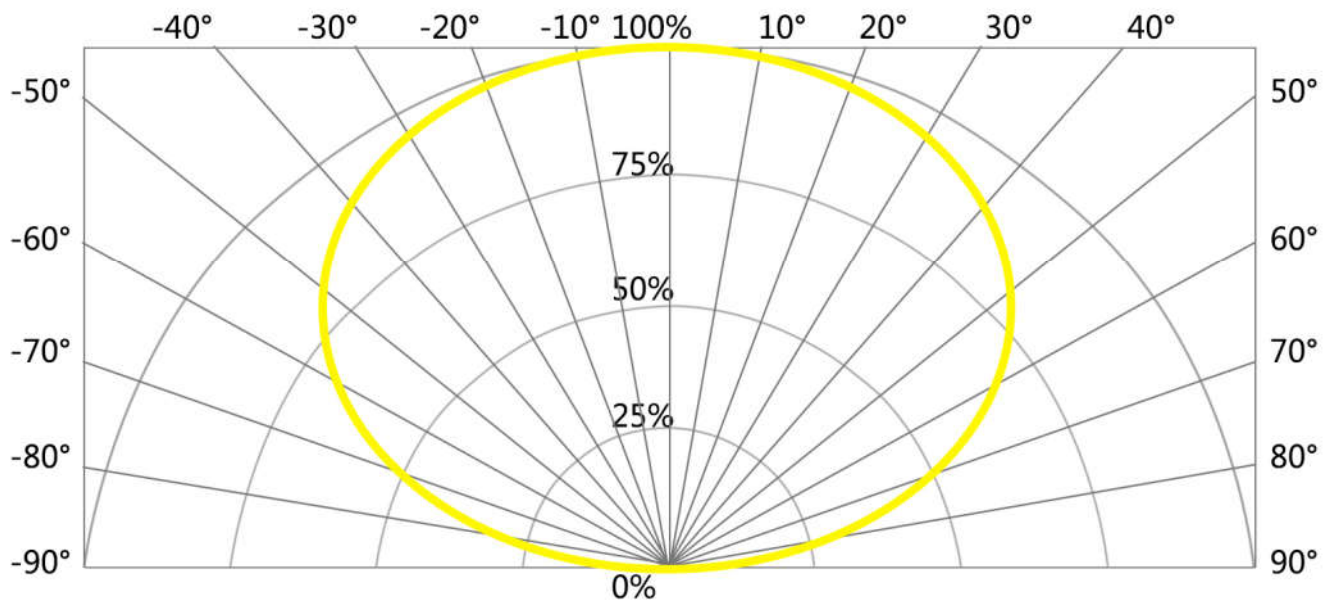

## 8.Cautions

### 1. Electrostatic Treatment

Do a full range of anti-static measures (such as: anti-static ring, anti-static clothes, machine, equipment grounding wire, etc.)



### 2. Heat Dissipation

A、 It is recommend to configure reasonable heat dissipation device for the product.

B、 The best working temperature range of the product is 40-60°. It is recommended to control the working temperature of the product within a reasonable range.

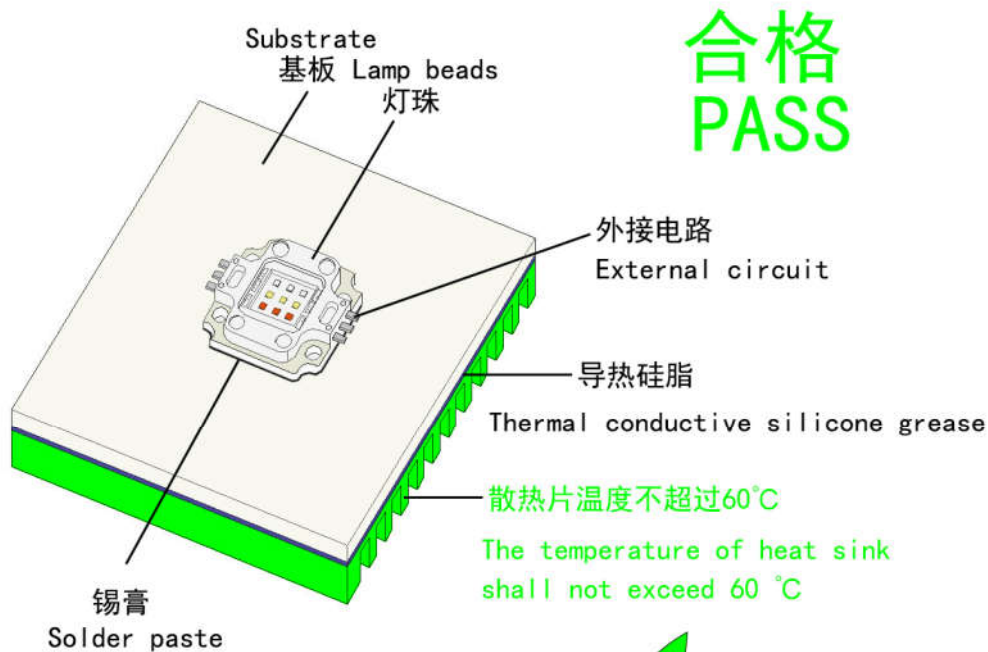

合格  
PASS

OK

